

Recovery of chlorine from dilute hydrochloric acid by electrolysis using a chlorine resistant anion exchange membrane

V. BARMASHENKO and J. JÖRISSEN*

Department of Biochemical and Chemical Engineering, Technical Chemistry A, University of Dortmund, D-44221, Dortmund, Germany

*(*author for correspondence, e-mail: joerissen@bci.uni-dortmund.de)*

Received 20 January 2005; accepted in revised form 10 August 2005

Key words: anion exchange membrane, chlorine, electrolysis, hydrochloric acid

Abstract

A new chlorine resistant anion exchange membrane enables innovative possibilities for hydrochloric acid electrolysis for recovery of chlorine. This is of interest for hydrochloric acid that is neutralized in the chemical industry because purity and concentration are not sufficiently high for recycling. In the common electrolysis process hydrochloric acid is fed into the anode compartment and needs a satisfactory HCl concentration for supplying the anode with chloride ions. Using an anion exchange membrane as a cell separator the feed flows into the cathode chamber where a low HCl concentration is acceptable because Cl^- ions at the anode can be supplied by addition of a salt which is not consumed. Experimental data of the membrane and the process are presented: membrane permselectivity improved up to above 97% using CaCl_2 as added salt, chlorine current efficiency up to 98% and oxygen content as low as 0.5 vol%, cell voltage at 4 kA m^{-2} 2.3 V, equivalent to 1740 kWh per t produced chlorine, even at low HCl concentrations. Thus, the power consumption is comparable with the common process. A problem of the new process is the high water transport through the membrane. Therefore, experiments for two process alternatives were carried out. Disadvantages of water transport can be avoided by using a high concentrated CaCl_2 solution as anolyte and catholyte and as absorption medium for diluted HCl gas streams. Additionally, a cell design was investigated where the anode is directly connected to the membrane in an empty (gas filled) anode compartment.

1. Introduction

Large amounts of hydrogen chloride are generated as a by-product of chlorine consuming processes in the chemical industry. In the majority of applications chlorine is used due to its high reactivity for production of chlorine containing intermediates, e.g. phosgene or chlorinated aliphatic or aromatic compounds. Hydrogen chloride can be a direct by-product of chlorination, e.g. of substitution reactions, but mostly it is generated in subsequent production steps while removing chlorine atoms in order to attain chlorine-free final products. Especially in this case dilute hydrochloric acid is formed as a by-product.

Hydrochloric acid of high concentration and purity is a valuable product but usually it is produced by combustion of hydrogen with chlorine. If it is formed as a by-product it often cannot be used due to insufficient purity and/or too low concentration. This hydrochloric acid has to be neutralized, e.g. by addition of sodium or calcium hydroxide, and disposed of as a waste water of high salt content.

Neutralization of hydrogen chloride gives a 1.6-fold increased salt quantity. In consequence large amounts of chemicals are lost. Additionally, problems can occur in subsequent biological waste water treatment by too high salt concentrations. Generally, in the majority of cases disposal of salts in waste water is limited by legal restrictions.

About 1.4 million tons of hydrogen chloride (HCl) were produced in Germany in 1995 [1]. Fifty four percent was reused for chemical production, mainly for oxychlorination, together with oxygen instead of chlorine, e.g. in vinyl chloride manufacture via dichloroethane. Such processes need a sufficiently high HCl concentration. A further 10% of the HCl was sold for different applications.

The quantity of HCl, which was neutralized in industry in 1995, because no option for reuse was available, was 16% (=230,000 t HCl per year [1]). This amount is the target of the work described here. A new possibility for recovery of chlorine by electrolysis of dilute hydrochloric acid, in terms of production integrated environmental protection, is sought.

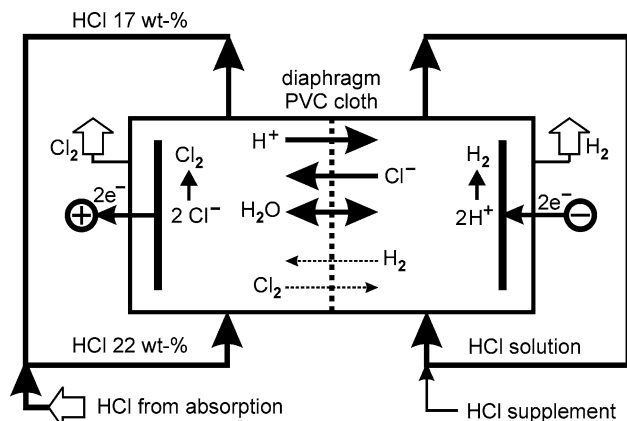

Fig. 1. Electrolysis of hydrochloric acid in diaphragm cells.

2. State of the art in hydrochloric acid electrolysis

Industrial electrolysis of hydrochloric acid for recovery of chlorine has been commonly carried out since 1964 using the well proven Bayer–Hoechst–Udde process, shown in Figure 1 [2–4]. In Germany in 1995 20% of the HCl produced was recycled in this way, mainly from isocyanate manufacture via phosgene. The worldwide capacity of this process is about 500,000 t HCl per year.

HCl gas is absorbed in water and fed to the anode chamber of the electrolyzer. The cells contain bipolar electrodes of graphite and woven diaphragms of PVC fiber (poly (vinyl chloride)), probably improved by PVDF (poly (vinylidene fluoride)). At the anode pure chlorine is evolved, as long as the HCl concentration is at least 17 wt%. At lower HCl concentrations graphite is attacked by oxygen evolution [4]. The gas purity is limited because the porous diaphragm cannot impede gas diffusion completely in both directions.

Gases of increased purity can be obtained by replacing the diaphragm by a cation exchange membrane which is almost exclusively permeable for H^+ ions according to Figure 2. The hydration shells of the H^+ ions in the membrane generate the electro-osmotic drag of water (EOD, e.g. [5]). In consequence, a recycle stream from the catholyte into the anolyte and a supplement of HCl into the catholyte are necessary.

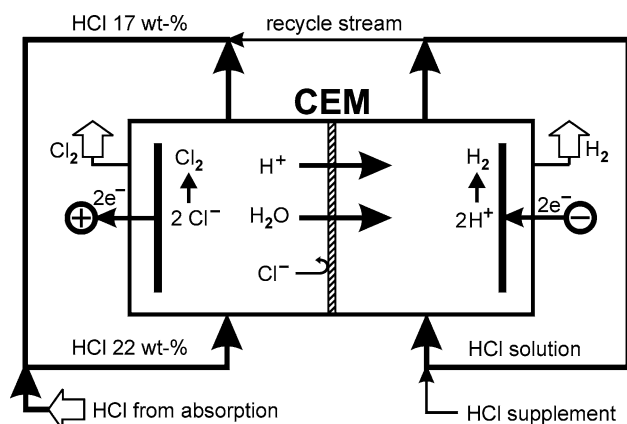

Fig. 2. Electrolysis of hydrochloric acid using a cation exchange membrane CEM.

Stable and well proven perfluorinated cation exchange membranes are available, similar to those used in chlor-alkali electrolysis e.g. Nafion[®] (Du Pont), but the price of these membranes is high.

A general difficulty remains: the hydrochloric acid is fed to the anode compartment and the anolyte HCl concentration has to be 17 wt% or higher if graphite anodes are used. In chlor-alkali electrolysis dimension stable anodes (DSA[®]) are applied. These are made of titanium base metal with a mixed oxide coating, especially of different platinum metals like ruthenium and iridium and valve metals like titanium and tantalum. To utilize DSA in pure hydrochloric acid solutions is difficult. Corrosion is possible at HCl contents above 5 wt% but, on the other hand, this concentration may be too low to sufficiently supply the anode with Cl^- ions in order to obtain optimal, oxygen free chlorine evolution.

Numerous patents for hydrochloric acid electrolysis with cation exchange membranes have been published since 1978 [6]. Different types of electrode are recommended. Included are gas diffusion electrodes, also directly laminated with the membrane (“Membrane Electrode Assembly”, MEA), known from fuel cell technology, e.g. [7–9]. Also gaseous HCl may be electrolyzed using this technique, e.g. [10, 11]. Oxygen consuming cathodes, instead of hydrogen evolving cathodes in Figure 2, can decrease the cell voltage in order to save electrical energy, theoretically by 1.23 V, actually in reality by about 0.9–1.0 V, e.g. [12–14]. The combination of HCl gas phase electrolysis with oxygen consuming cathodes enables very high current densities e.g. [15].

In 2003 the Bayer AG and Uhdendorf S.p.A. successfully realized a hydrochloric acid electrolysis with a capacity of 10,000 t per year (meanwhile increased to 20,000 t a⁻¹) using cation exchange membranes and oxygen consuming cathodes, based on rhodium sulfide catalysts [16, 17].

All these industrial processes operate with the usual high HCl concentrations. No electrolysis process for dilute hydrochloric acid has been realized. Some electrolysis cells, using membrane electrode assemblies (MEAs), allow depletion of HCl to lower concentrations. For instance, the application of MEAs, based on carbon black, enable the electrolysis of dilute HCl down to 3 wt% [9]. Using fluidized-bed electrodes wastewaters with a small content of HCl, e.g. from scrubbing municipal refuse incineration gases, are treated to recover Cl_2 and H_2 , which then can be recombined to HCl of high concentration [18]. Similarly, the combination of absorption and fixed-bed electrolysis [19] may be suitable to recover Cl_2 from HCl.

3. Hydrochloric acid electrolysis using an anion exchange membrane as cell separator

New opportunities, especially for electrolysis of dilute hydrochloric acid, are available using anion exchange

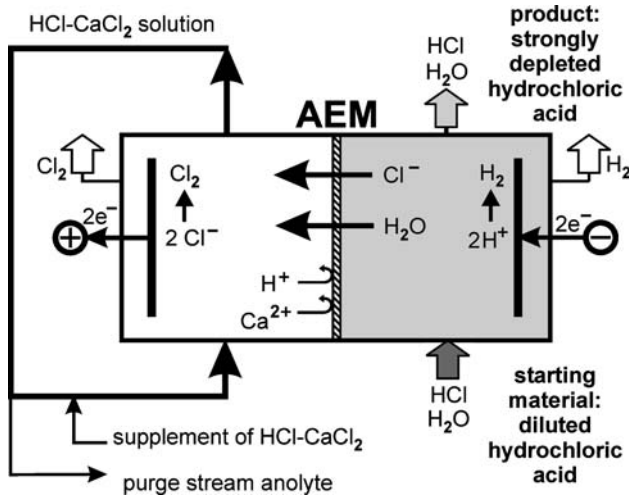

Fig. 3. Electrolysis of hydrochloric acid using an anion exchange membrane AEM as cell separator.

membrane cell separators according to Figure 3. Charge transfer through the membrane occurs via Cl^- anions and the feed flows into the cathode compartment. Here the depletion of the hydrochloric acid is not limited by the cathode reaction which takes place even at very low HCl concentrations because no competitive reactions occur. However the HCl concentration has to be sufficiently high so that sufficient Cl^- anions are delivered into the membrane.

An essential advantage of this process configuration is the possibility of adding a salt into the anolyte, e.g. sodium or calcium chloride, in order to increase the Cl^- anion concentration for optimal, oxygen free anodic chlorine evolution without increase in HCl concentration.

A problem, that will be discussed in section 5.1.4, is the changed direction of the electro-osmotic water transport within the hydration shells of the Cl^- anions inside the membrane, enhanced by diffusion of water from the catholyte (high water concentration) into the anolyte (high salt content = low water concentration). This necessitates a purge stream from the anolyte, which includes salt and has to be disposed of, and in consequence a supplement of salt into the anolyte is needed (see Figure 3).

Common anion exchange membranes, typically designed for electrodialysis, are very sensitive to oxidative conditions and will be immediately damaged by chlorine. A process design according to Figure 3 is possible using the AEM "MAP-1", based on methyl vinyl pyridine, which has been developed for diffusion dialysis in Russia (Research Institute of Plastics G.S. Petrov, Moscow). The investigated membrane samples without reinforcement had a thickness of about 0.1 mm. Improved types of this AEM are now available from Fumatech GmbH, St. Ingbert, Germany (type FAP). The price is expected to be lower compared with that of perfluorinated cation exchange membranes like Nafion[®]. The AEM has shown stability against chlorine, e.g. during electrolysis of hydrochloric acid (520 h,

4 kA m⁻², 60 °C) and for more than 1000 h in industrial experiments.

4. Experimental

In order to obtain general information about the behavior of the anion exchange membrane MAP-1, especially about its transport properties, measurements were performed using a cell configuration as in Figure 3 with constant cell current under continuous operation [20]. The cylindrical glass cells had 52 mm inner diameter and 9 mm wall thickness, the active membrane area was 21.2 cm². In most cases a titanium anode (plate or expanded metal) and a graphite cathode (Diabon NS2, SGL) were used. The anode coating of ruthenium/titanium oxides was made in-house [21] and showed sufficient durability. The electrode-membrane distance was usually 42 mm in order to avoid the direct influence of the electrodes on the membrane and to enable good mixing of the liquid via magnetic stirrers for optimal mass transfer.

Additionally, two other cathode materials were tested in some experiments with an electrode distance of 3 mm: an alloy of predominantly nickel, chromium and molybdenum (Nicrofer 5923 HMO, Ni 59, Cr 23, Mo 16) and a titanium expanded metal with a platinum metal coating (by thermal decomposition of H_2PtCl_6 at 500 °C). With both of these cathode materials measurements over several days were possible, but traces of corrosion indicated insufficient long-term stability.

The feeds for both cell compartments were dosed by magnetic membrane pumps (CFG Prominent) with subsequent temperature control using electrical heaters. The anode gas streamed upwards through a helical glass tube (10 mm inner diameter, 1 m length). Counter-current downward flowing caustic soda solution (15 wt%) absorbed the contained chlorine completely, without any pressure drop in the gas flow. The chlorine in the anode gas was quantified using the weight of the absorption solution and analysis of sodium hypochlorite formed. The remaining gas stream was measured volumetrically and then samples were analyzed for oxygen and nitrogen by gas chromatography (Hewlett-Packard 5918 with thermal conductivity detector and 3390 A integrator, 30 m molecular sieve column).

All analyses of liquid samples were performed by automatic potentiometric titration (Metrohm 785 DMP Titrimo): H^+ ions with caustic soda solution using a glass electrode, Cl^- ions with silver nitrate solution using a chloride ion specific electrode (AgS), sodium hypochlorite or dissolved chlorine in the anolyte with sodium arsenite solution using a platinum electrode.

The duration of each experiment was at least 20 and up to 520 h. Measurements were not started before reaching steady state with stable cell voltage and constant anolyte and catholyte concentrations (checked by repeated analysis). Using the weights of anolyte and catholyte feed and outlet streams and their

analyses of H^+ and Cl^- ions enables balances of the ion streams through the membrane.

5. Results

5.1. Cell design with liquid anolyte filled anode chamber

5.1.1. Selectivity of MAP-1 membrane for Cl^- ions

Ideally, the ion transport in an anion exchange membrane should exclusively be carried out by anions, here by Cl^- anions. Then, the permselectivity (permeation selectivity) of the membrane would be 100%. In reality, cations will also be transferred through the membrane: by migration in the electrical field as well as by diffusion due to concentration differences. Especially the very mobile H^+ cations cannot sufficiently be rejected (this will be no problem here, see Figure 3). But the transfer of metal ions of the salt, which is added to the anolyte for increased Cl^- anion concentration, through the membrane into the catholyte is unfavorable. Salt is lost from the anolyte and has to be supplemented. Further it must be removed from the catholyte and deposited.

The results of Cl^- ion balances in Figure 4 using sodium chloride in the anolyte showed that nearly 10% of the cell current was transported not by Cl^- anions but by Na^+ cations. As expected, the double charged Ca^{2+} ions were better retarded under the same conditions. Using calcium chloride it was possible to increase the selectivity for Cl^- anions above 97%. The generally observed increasing selectivity with increasing current density may be caused by rejection of cation transfer by the increasing counter-current flow of hydrated Cl^- anions. Calcium chloride is cheap and adequately soluble in hydrochloric acid solutions, e.g. 30 wt% $CaCl_2$ in 15 wt% HCl at 20 °C.

For a process modification, using a $CaCl_2$ solution for HCl absorption (see section 5.1.5 and Figure 9), several experiments were carried out with addition of $CaCl_2$ to both cell chambers.

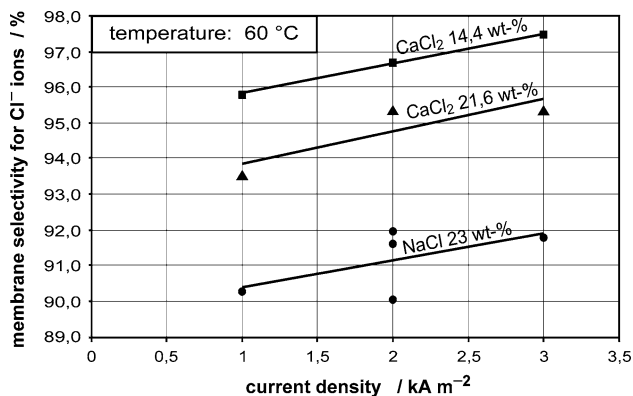

Fig. 4. Permselectivity for Cl^- anions of the MAP-1 anion exchange membrane as function of the current density and of kind and concentration of the salt, used in the anolyte feed.

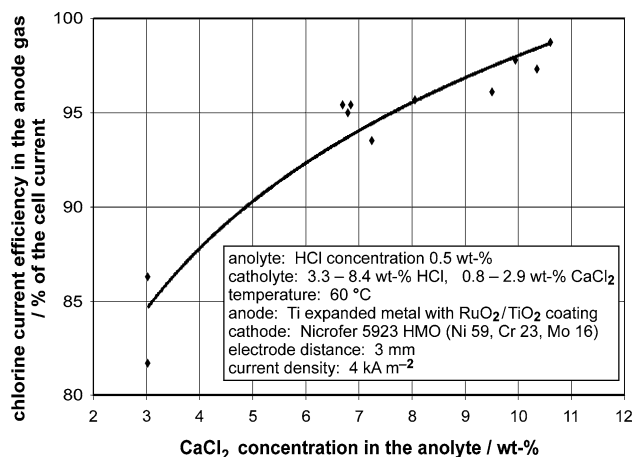

Fig. 5. Increase of the chlorine current efficiency in the anode gas as function of the anolyte calcium chloride concentration.

5.1.2. Current efficiencies of the anode gases

The results in Figure 5 confirm that the current efficiency for chlorine formation can be improved significantly by increase of the Cl^- anion concentration, here from calcium chloride. 10 wt% of $CaCl_2$ are sufficient for 98% chlorine current efficiency (only the chlorine in the anode gas is included here, an additional small amount of chlorine was dissolved in the anolyte outlet). The HCl concentration in the catholyte was low, especially in comparison with the Bayer–Hoechst–Uhde process. The catholyte feed was pure dilute hydrochloric acid. The salt content of the catholyte was caused by transfer of Ca^{2+} ions through the membrane.

Anodic oxygen formation was measured under comparable conditions on the anode side as shown in Figure 5. For 240 h the oxygen current efficiency was below 1%, i.e. the oxygen content in the anode gas was lower than 0.5 vol%.

5.1.3. Cell voltage using the MAP-1 membrane

In order to achieve a favorable specific power consumption [kWh per ton of produced chlorine] a low cell voltage is necessary: this is especially influenced by the voltage drop through the membrane.

The results in Figure 6 were measured using two Luggin capillaries, positioned as close to the membrane surfaces as possible, in the cell configuration with the wide electrode distance. A linear dependence of voltage drop on current density is observed. At the origin of the curves negligible differences at zero cell current occur.

Here the anolyte and the catholyte contained high concentrations of $CaCl_2$ (see section 5.1.5. and Figure 9). Hydrochloric acid was fed to the catholyte, but HCl was also transferred through the membrane into the anolyte. In steady state operation the HCl concentration in the anolyte reached about one third of that in the catholyte.

Clearly, the voltage drop of the membrane decreases significantly with increasing HCl concentration. At the common industrial current density of $4 kA m^{-2}$ and the relatively low HCl concentration of 11 wt% in the

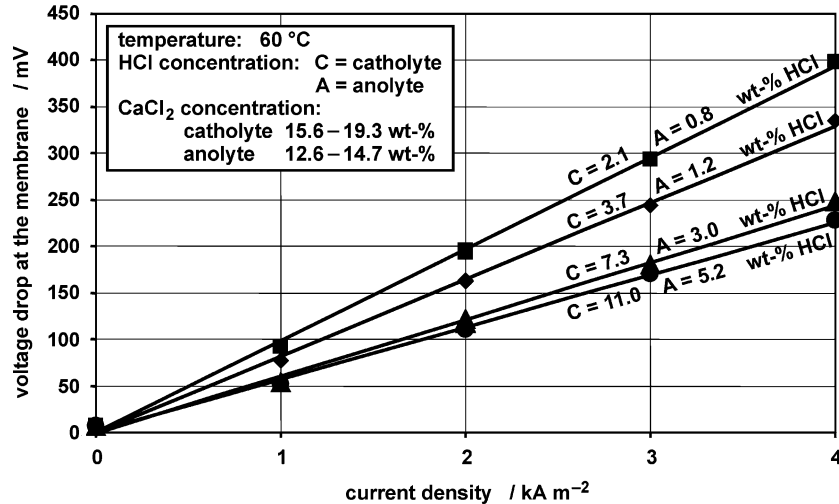

Fig. 6. Voltage drop at the membrane MAP-1 as a function of current density and HCl concentration at nearly constant CaCl₂ content.

catholyte and 5.2 wt% in the anolyte the membrane voltage drop was about 0.2 V. With further decrease in HCl concentration to 2.1 wt% in the catholyte and 0.8 wt% in the anolyte the voltage drop remained below 0.4 V.

In order to measure realistic values of the cell voltage additional experiments were performed in the concentration range of the upper two curves of Figure 6. A cell configuration with two differently coated titanium expanded metal electrodes with 3 mm distance was used.

The example in Figure 7 shows a cell voltage of approx. 1.5 V at the low current density of 1 kA m⁻², i.e. only slightly above the thermodynamic decomposition voltage of HCl (1.35 V) in addition to the small membrane voltage drop of about 0.1 V from Figure 6. The increase in cell voltage at higher current density is more than linear and generally enhanced in comparison with the membrane voltage drop in Figure 6. Here, the increase in the electrolyte resistance due to the gas evolution is included.

At 4 kA m⁻² the cell voltage in Figure 7 is 2.3 V, including about 0.4 V membrane voltage drop (taken from Figure 6). Thus, the energy demand results in 1740 kWh per ton of chlorine. The Bayer–Hoechst–Udde process started in 1964 with about 1900 kWh t⁻¹ and by optimization, especially addition of depolarizing agents, 1450 – 1500 kWh t⁻¹ were achieved (1985) [4]. That means that for a process using the MAP-1 membrane a comparable electrical energy consumption can be expected as in the common electrolysis process. For comparison, the decreased HCl concentration and, in consequence, the lower conductivity in the new process should be taken into account.

5.1.4. Water transfer through MAP-1 membrane

The importance of water transfer through the membrane has already been mentioned in section 3. Figure 8 shows results as examples of experiments with high CaCl₂ concentration in the anolyte, but no CaCl₂ addition to the catholyte feed of pure dilute hydrochloric acid, i.e.

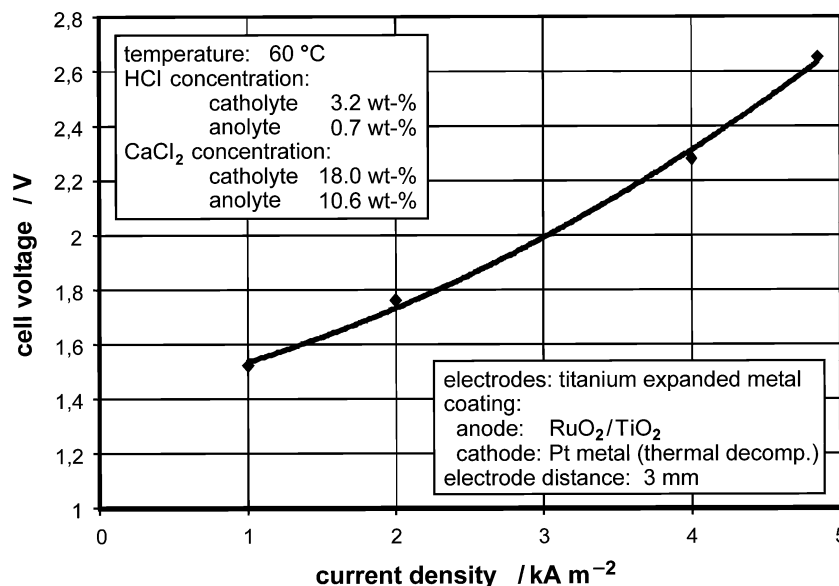

Fig. 7. Cell voltage as a function of the current density.

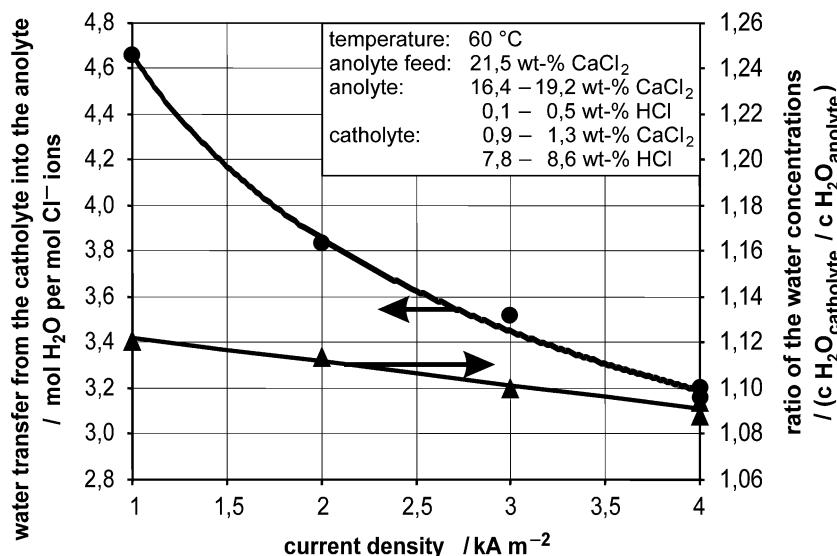

Fig. 8. Example for the water transfer through the MAP-1 anion exchange membrane (no CaCl_2 addition into the catholyte).

the analyzed CaCl_2 in the catholyte has been transferred through the membrane. Water will be transported from the catholyte into the anolyte through the membrane in the hydration shells of Cl^- anions (electro-osmotic drag EOD) and additionally in the same direction by diffusion, due to the higher water concentration in the catholyte compared with the anolyte. Further, water can be transferred in the opposite direction together with H^+ ions.

The effective water transfer, known from the water balance of the continuously operated experiments in steady state, is calculated in Figure 8 in relation to the transport of Cl^- anions (left ordinate, curve with round points). There is a significant decrease in this water amount with increasing current density. Figure 8 also shows the ratio of the water concentrations in the catholyte and anolyte (right ordinate, curve with triangles). It is not far away from one, i.e. there is only a small excess of water concentration on the cathode side and this is scarcely influenced by current density.

An approximate estimation of the water transfer mechanism may be possible using a simplified model:

- water diffusion will be dependent on the concentration ratio but will not be influenced by current density,
- the EOD should be proportional to current density, i.e. the hydration shells of the Cl^- anions are independent of current density,
- any EOD together with H^+ ions is neglected.

This estimation results in all four measurement points in Figure 8 being fitted if an effective hydration shell of the Cl^- anions in the range 2.7 $\text{mol H}_2\text{O}$ per mol Cl^- anions is assumed. In consequence, the fraction of diffusion at 1 kA m^{-2} should be about 40% and 60% EOD, but at 4 kA m^{-2} nearly 85% EOD and only 15% diffusion.

Nevertheless, this water transfer through the membrane, observed values range from more than 3 up to nearly 5 $\text{mol H}_2\text{O}$ together with each mol Cl^- anions, is a problem for the process in Figure 3 because water has

to be removed from the anolyte. In Figure 3 a simple purge stream is provided. This causes a loss of salt and hydrochloric acid, which have to be replenished. In principle, other methods, like evaporation or membrane processes like reverse osmosis, may be possible but need additional investment.

5.1.5. Alternative process without problems caused by water transfer

In order to avoid problems, caused by the water transfer through the membrane, the alternative process design in Figure 9 has been developed and measurements of the water transfer to simulate its operation conditions were carried out. A solution with a high content of about 20 wt% calcium chloride was used as electrolyte in both cell compartments. In the complete process it will also be the absorbent in an absorption column. Experimental results under these conditions show that water transfer through the membrane of only about 1 $\text{mol H}_2\text{O}$ per mol Cl^- anions can be expected due to the decreased hydration shell of the Cl^- anions in the membrane at the low water concentration (high salt concentration). Thus, only a small amount of anolyte has to be purged and can easily be recycled to the catholyte (traces of dissolved chlorine are reduced at the cathode without problems).

Even though this process is not able to electrolyze dilute hydrochloric acid directly it can be advantageous for dilute, hydrogen chloride containing gas streams. The calcium chloride solution in the absorption column allows removal of HCl gas down to very low concentrations. Subsequently, the HCl is converted in the electrolyzer to chlorine due to the high Cl^- anion concentration under optimal conditions.

5.2. Cell configuration with empty (gas filled) anode compartment

In consequence of the high water transfer through the membrane MAP-1 and the resulting problems for

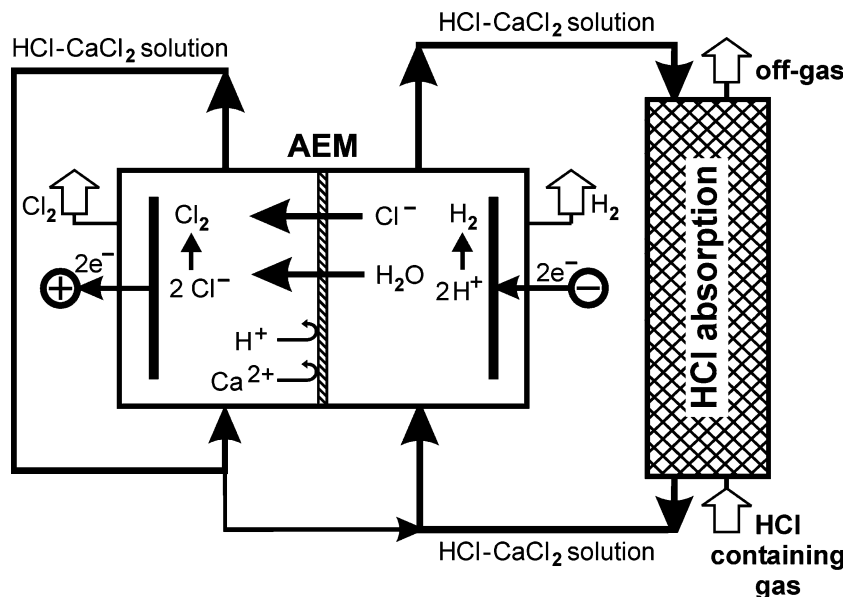

Fig. 9. Electrolysis of hydrochloric acid with an anion exchange membrane AEM in combination with a HCl gas absorption, using a HCl-CaCl₂ solution as gas absorbent and electrolyte.

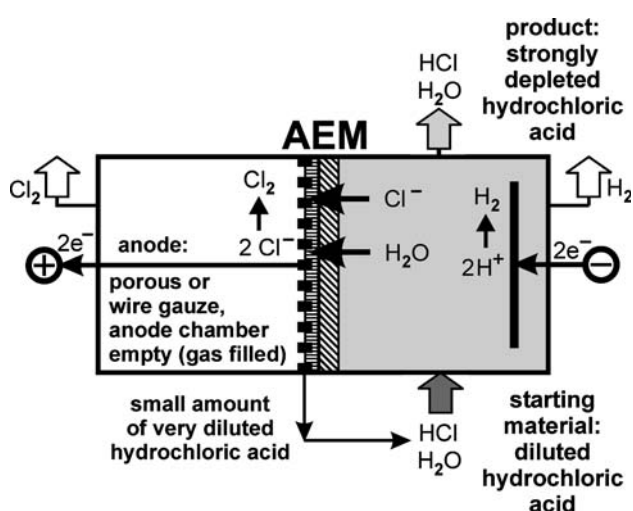

Fig. 10. Electrolysis of hydrochloric acid using an anion exchange membrane AEM with empty (gas filled) anode chamber.

industrial realization a further cell design has been developed and tested.

In the cell configuration in Figure 10 no liquid anolyte filling is used, i.e. the anode compartment is empty, only filled with the anode gas (chlorine). The anode is made of a porous material or of a metal wire gauze, directly pressed on the membrane surface or connected with it. Only a small amount of liquid is collected in the anode compartment and this can easily be recycled into the catholyte.

The basic idea of this concept is that the Cl⁻ anions, which arrive through the membrane at the anode, will be available directly for optimal chlorine evolution.

In initial experiments graphite felt, pressed onto the membrane surfaces, was applied for both electrodes. On the anode side the felt was destroyed, probably by oxygen formation. On the cathode side it hindered the mass transfer because it lost its hydrophilic properties

and then the evolved hydrogen displaced the catholyte solution.

The results in Fig 11 show that the desired function of the electrolysis is in principle possible, at least for a high catholyte HCl concentration, comparable with the Bayer-Hoechst-Uhde process. But for decreasing catholyte HCl concentrations significant reduction in chlorine current efficiency occurs at higher current densities. Different metal wire gauzes were tested and a titanium gauze with RuO₂/TiO₂ coating gave slightly better results. Photographs of the membranes after usage showed that the contact between a wire gauze and the membrane may be insufficient. Thus, electrodes with improved connection between the electrode material and the membrane are necessary.

This is a special task in the Solid Polymer Electrolyte technology (SPE) which, in principle, is applied in the cell shown in Figure 10. It is commonly utilized with cation exchange membranes in different concepts of hydrochloric acid electrolysis (see section 2) and especially in the Proton Exchange Membrane Fuel Cell (PEMFC). In fuel cells the performance of a Membrane Electrode Assembly (MEA), i.e. a gas diffusion electrode which is laminated with the membrane, depends on the following properties, which are also needed for hydrochloric acid electrolysis in a cell configuration like that in Figure 10:

- optimal electrical contact (electron conduction) of the electro-catalyst particles with the current collector (in fuel cells commonly realized by carbon black, loaded with a platinum metal catalyst),
- optimal contact (ion conduction) of the electro-catalyst particles with the ion exchange membrane, i.e. the solid polymer electrolyte (in fuel cells commonly realized by embedding of the electro-catalyst into dissolved membrane material and/or hot pressing with the membrane). Here in hydrochloric acid elec-

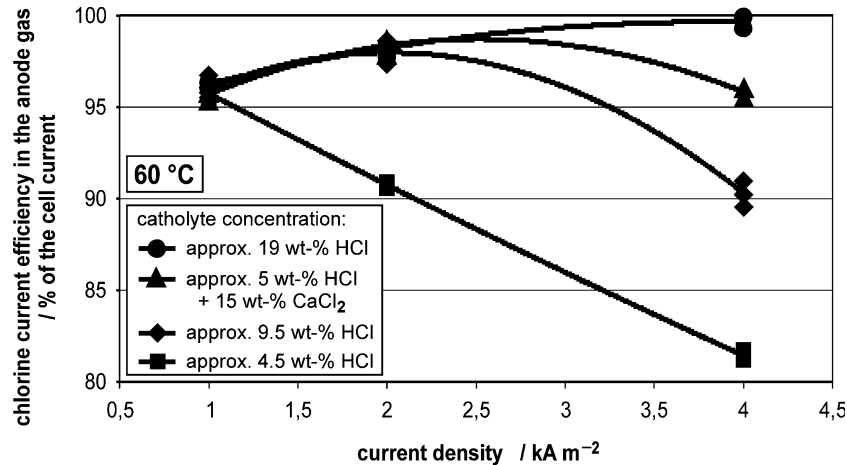

Fig. 11. Chlorine current efficiency in the cell configuration with empty (gas filled) anode compartment, using a titanium wire gauze anode, coated with platinum metal by thermal decomposition, as a function of current density and HCl concentration in the catholyte.

tolysis the ionic contact is intrinsically enhanced by liquid films of hydrochloric acid in the electrode structure,

- free gas transport in the porous electrode material. Especially in hydrochloric acid electrolysis the removal of chlorine without damage to the electrode structure by gas bubbles is needed. The addition of hydrophobic PTFE materials in order to provide gas channels, as known from fuel cells, should be improved.

Three different MEAs were prepared and applied as anodes at the low HCl catholyte concentration of 4.5 wt% at 4 kA m⁻². Figure 12 shows that the current efficiency was significantly increased in comparison with a Pt-Ir wire gauze anode and with the results of Figure 11. In these MEAs relatively large amounts of catalyst were used and the best results were achieved with increased catalyst load. Simultaneously with increasing current efficiency a decreasing cell voltage was observed

(from 3.5 to 2.6 V at 4 kA m⁻² for the MEAs in Figure 12).

These results show that the properties of MEAs have to be improved for increased electrical conductivity as well as for enhancement of ion transport and generally of mass transfer.

The experiments have verified that the process concept of Figure 10 is suitable for electrolysis of dilute hydrochloric acid. The possibility to increase the current density up to 8 kA m⁻² without decrease in current efficiency (see Figure 12) demonstrates that there is a considerable potential for optimization.

6. Conclusions

The results of this investigation confirmed that the application of the chlorine resistant anion exchange membrane MAP-1 enables new opportunities for hydro-

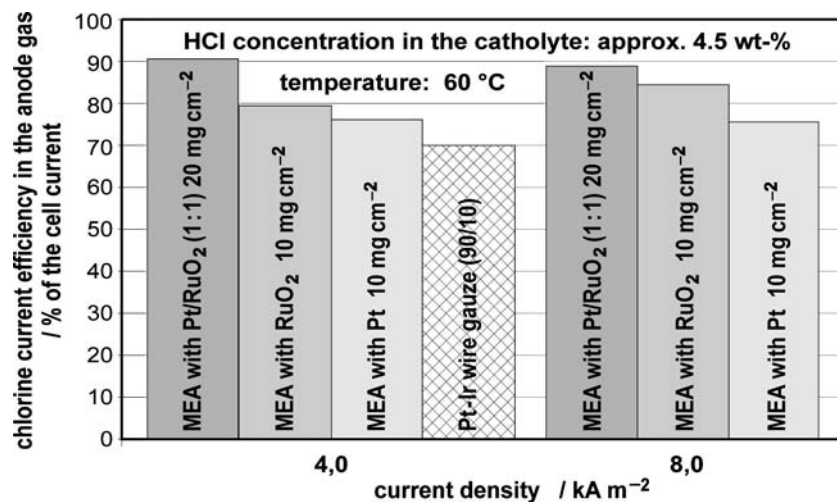

Fig. 12. Electrolysis of hydrochloric acid using an anion exchange membrane AEM with empty (gas filled) anode chamber and various Membrane Electrode Assemblies (MEAs) on the anode side (the MEAs were prepared by the Fumatech GmbH using methods of fuel cell technology; the membrane was pressed onto the anode MEAs by 250 mmH₂O hydrostatic pressure on the cathode side).

chloric acid electrolysis. Comparable performance and power consumption, with the common Bayer–Hoechst–Uhde electrolysis process, was achieved, not only at the usual high HCl concentrations but also at decreased hydrochloric acid content.

The voltage drop of the membrane increases with decreasing HCl concentration, but it remains in an acceptable range even for very low HCl concentrations (below 0.4 V at 2.1 wt% HCl and 4 kA m⁻²).

Calcium chloride has been found to be a suitable salt to increase the chloride ion concentration in the anolyte while using the MAP-1 membrane. In a combination of an electrolysis cell, using the MAP-1 membrane, with an absorption column a CaCl₂ solution will be suitable to recover chlorine even from very dilute HCl containing gas streams.

The water and salt transfer through the membrane restricts the range of concentrations and must be taken into account for the optimization of operating conditions.

The cell design with a gas filled anode compartment and the anode in direct contact with the membrane may be interesting for ease of operation.

The stability of the MAP-1 membrane has been confirmed by a long term experiment of 520 h (= 22 days) in this project and also by industrial tests over more than 1000 h.

The next development step should be an investigation using hydrogen chloride from a real chemical process under industrial conditions in order to optimize the operation parameters.

Acknowledgements

The authors acknowledge financial support from the Arbeitsgemeinschaft industrieller Forschungsvereinigungen (AiF, funds of the Ministerium für Wirtschaft of the Federal Republic of Germany, AiF-No. 12774 N). They thank the DECHEMA e.V., Frankfurt am Main, for organizational help, and the Fumatech GmbH, St. Ingbert for membrane samples and preparation of membrane electrode units.

References

- Information received from 'Verband der Chemischen Industrie' (VCI), (Frankfurt am Main, Germany, 2002).
- Chlorine, Electrolysis of Hydrochloric Acid, in Ullmann's Encyclopedia of Industrial Chemistry, 7th ed., (WILEY-VCH, Weinheim, Electronic Release 2005).
- H. Hölemann, *Chem. Ing. Tech.* **34** (1962) 371.
- H. Isfort and W.-J. Stockmans, DECHEMA-Monographs 98 (1985) 141, VCH, Weinheim 1985.
- S. Motupally, A.J. Becker and J.W. Weidner, *J. Electrochem. Soc.* **149** (2002), Nr. 5, D63.
- US 4,107,005, 'Process for electrolysing sodium chloride or hydrochloric acid, an and electrolytic cell, employing trifluorostyrene sulfonic acid membrane', Hooker Chemicals & Plastics Corporation (Inv.: V.F. D'Agostino, J.Y. Lee and E.H. Cook, Jr.), Aug. 15, 1978.
- US 4,210,501, 'Generation of halogens by electrolysis of hydrogen halides in a cell having catalytic electrodes bonded to a solid polymer electrolyte', General Electric Co. (Inv.: R.M. Dempsey, T.G. Coker and A.B. La Conti), July 01, 1980.
- US 6,066,248, 'Process for aqueous HCl electrolysis with thin film electrodes', E.I. du Pont de Nemours and Company (Inv.: S.E. Lyke and P. Tatapudi), May 23, 2000.
- DE 100 48 004 A1, 'Verfahren zur Elektrolyse wässriger Salzsäurelösungen', Degussa AG, (Inv.: will be specified later), Apr. 11, 2002.
- US 5,411,641, 'Electrochemical conversion of anhydrous hydrogen halide to halogen gas using a cation-transporting membrane', E.I. Du Pont de Nemours and Company (Inv.: J.A. Trainham, III, C.G. Law, Jr., J.S. Newman, K.B. Keating and D.J. Eames), May 02, 1995.
- US 5,798,036, 'Electrochemical conversion of anhydrous hydrogen halide to halogen gas using a membrane-electrode assembly or gas diffusion electrodes', E. I. Du Pont de Nemours and Company (Inv.: W.H. Zimmerman, T.F. Saturno, J.S. Artysiewicz, J.A. Trainham, C.G. Law, Jr., J.S. Newman and D.J. Eames), Aug. 25, 1998.
- EP 0 785 294, 'Improved method for the electrolysis of aqueous solutions of hydrochloric acid', De Nora S.P.A. (Inv.: G.N. Faita), Sep. 04, 1997.
- EP 0 931 857, 'Catalysts for gas diffusion electrodes', De Nora S.P.A. (Inv.: R.J. Allen, D. Czerwiec, J.R. Giallombardo and K. Skaikh), Sep. 02, 1999.
- EP 1 313 893, 'Process for the electrolysis of technical-grade hydrochloric acid contaminated with organic substances using oxygen-consuming cathodes', Bayer AG, De Nora Elettrodi S.p.A., (Inv.: R.J. Allen, R.J. Giallombardo, D. Czerwiec, S. De Castro, K. Skaikh, F. Gestermann, H.-D. Pinter, and G. Speer), July 03, 2003.
- US 6,368,490, 'Method for electrochemically processing HCl gas into highly pure chlorine', Bayer AG, (Inv.: F. Gestermann), Apr. 09, 2002.
- G. Corti and M.B. Borghesi, Future technology based on GDE (Gas diffusion electrodes) for sodium chloride and HCl electrolysis, 7th Asian Chlor-Alkali Conference, Singapore, June 27–28, 2002.
- Bayer AG, (<http://www.research.bayer.de/medien/pages/2867/Elektrolyse.pdf>).
- EP 0 518 075 B1, 'Process and device for reprocessing contaminated water containing hydrochloric acid', Sigrü Great Lakes Carbon GmbH, (Inv. G. Härtel, W. Meissner and J. Künzel), May 5, 1992.
- G. Kreysa, *Chem. Ing. Tech.* **62** (1990) 357.
- J. Jörissen, Report AiF-Nr. 12774 N, University of Dortmund, 2003.
- DE 1 671 422, 'Elektrode zur Verwendung in elektrolytischen Prozessen und Verfahren zu deren Herstellung', Chemnor AG, (Inv.: H.B. Beer), June 16, 1971, (example 1 has been used).